

# MX.250.P110

1 - 10 %

2,5  
m<sup>3</sup>/h

Massima portata motore  
Maximum motor flow rate



ITA QUOTE (mm) | GB DIMENSIONS (mm)

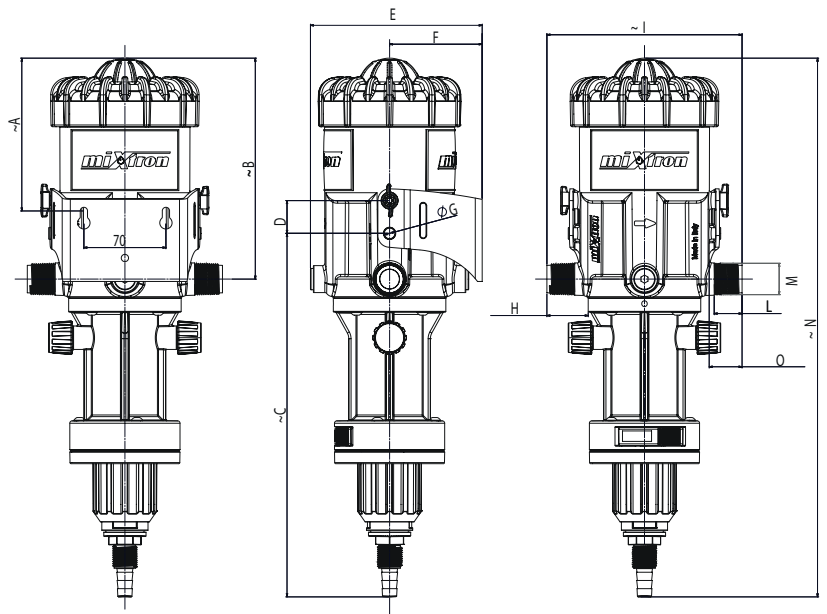

	mm	inches		mm	inches		mm	inches
A	130	5,12	F	79	3,11	M	3/4" BSPT	3/4" BSPT
B	188,5	7,42	G	Ø 10	Ø 0,39	N	~ 460	~ 18,11
C	310,1	12,21	H	35,3	1,39	O	28	1,1
D	28	1,1	I	~ 166,5	~ 6,56			
E	164,5	6,48	L	23,8	0,94			

ITA CARATTERISTICHE | GB CHARACTERISTICS

Dosaggio min/max %  
Min/Max dosing ratio %

1 - 10 %

Min/Max rapporto dosaggio  
Min/Max dosing ratio

1:100 ; 1:10

Max portata motore  
Max water flow

2.500 l/h

Componenti plastici  
Plastic components

POM, PP, HDPE

Componenti metallici  
Metal components

AISI 316, Duplex

Guarnizioni  
Seals

Viton, EPDM

Pressione di lavoro  
Operating pressure

0,3 - 6 bar

Massima pressione statica  
Max static pressure

10 bar

Temperatura  
Temperature

5° - 40° C

ITA Grafico perdite di carico - pompa 1 - 10 %

GB Flow Resistance Graph - pump 1 - 10 %

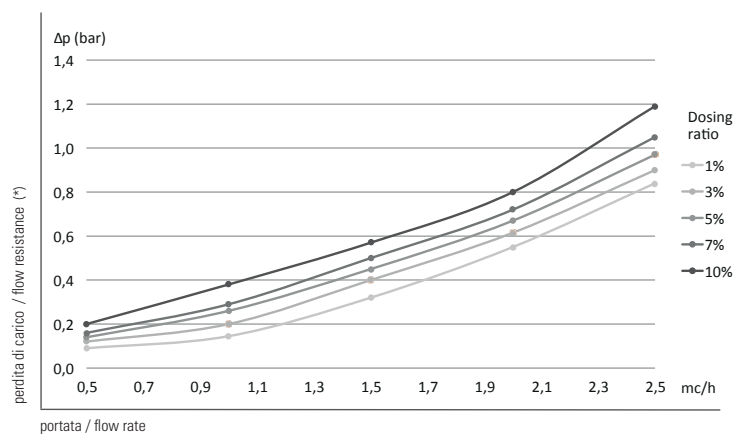

ITA OPTIONAL | GB OPTIONAL

ON/OFF



FLANGIA BARILE / BARREL FLANGE



SGANCIO RAPIDO / QUICK RELEASE



Ulteriori informazioni tecniche disponibili su richiesta  
Additional technical information available on request

**miXtron**